

# Parts Breakdown

Model FW-CN-0001-B 46687

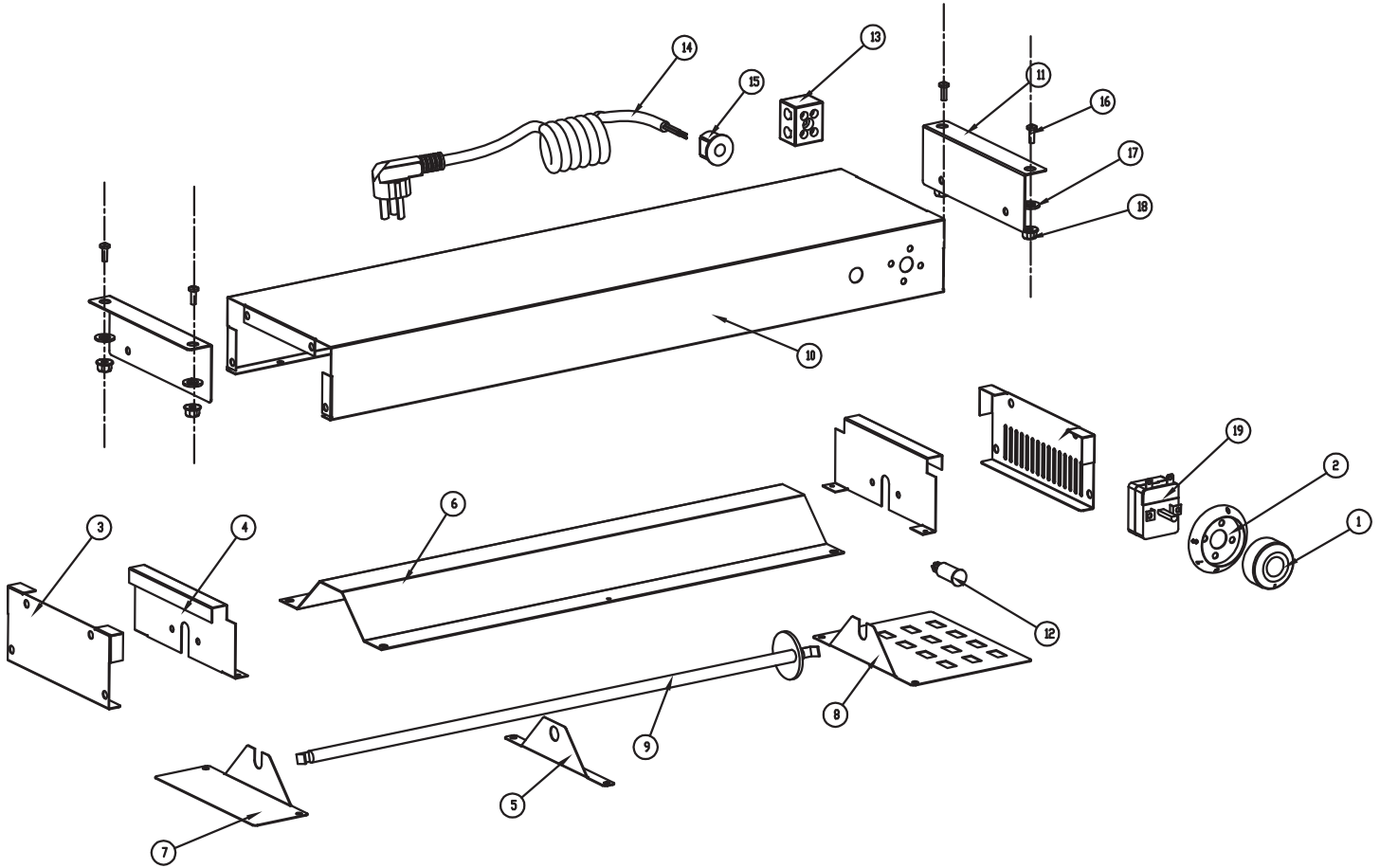

# Parts Breakdown

---

## Model FW-CN-0001-B 46687

Item No.	Description	Position	Item No.	Description	Position	Item No.	Description	Position
AD131	Knob for 46687	1	AD138	Bottom Board of Control Box for 46687	8	AD145	Power Cord Fixer for 46687	15
AD132	Knob Base for 46687	2	AD139	Heater for 46687	9	AD146	Screws for 46687	16
AD133	Left Side Board for 46687	3	AD140	Outer Cover for 46687	10	AD147	Washers for 46687	17
AD134	Top-Left Heater Fixer for 46687	4	AD141	Bracket for 46687	11	AD148	Nuts for 46687	18
AD135	Mid Heater Fixer for 46687	5	AD142	Indicator for 46687	12	AD149	Energy Regulator for 46687	19
AD136	Reflector for 46687	6	AD143	Terminal Block for 46687	13	AD150	Right Side Board for 46687	20
AD137	Bottom-Left Heater Fixer for 46687	7	AD144	Power Cord and Plug for 46687	14			